



MASSAVIDRO - MASSA PARA VIDRO, LDA



CATÁLOGO

Rua Sebastião e Silva, 47/49

2745-838 MASSAMÁ

Tel: 21 439 60 19 - 21 439 42 57/58 . Fax: 21 439 60 20

e-mail: EMAIL@MASSAVIDRO.PT



CATÁLOGO

- 01 ACESSÓRIOS PARA ALUMÍNIO
- 02 ALICATES DE VIDRACEIRO
- 03 BARRAS ANTI PÂNICO
- 04 BROCAS PARA VIDRO, FERRO E PEDRA
- 05 BUMPONS PARA QUADRO E OUTROS FINS
- 06 CAIXAS CORREIO DIVERSAS
- 07 CHAPAS DECORATIVAS EM ALUMÍNIO
- 08 CILINDROS PARA FECHADURAS
- 09 CINTAS LIXA PARA VIDRO
- 10 CINTEIS PARA CORTAR VIDRO
- 11 COLAS DIVERSAS
- 12 CORTA-VIDROS DIVERSOS (TOYO)
- 13 CREMONES SOFI-ALU ALPHA-MR-GNS
- 14 CUNHOS PARA ESQUADROS DE ALUMÍNIO
- 15 DISCOS DE CORTE PARA ALUMÍNIO E FERRO
- 16 DOBRADIÇAS NORMAIS E CÂMARA EUROPEIA
- 17 ELÉCTRODOS
- 18 ESPUMA DE POLIURETANO
- 19 ESQUADROS PARA ALUMÍNIO
- 20 FECHADURAS PARA ALUMÍNIO E VIDRO
- 21 FECHOS DIVERSOS PARA ALUMÍNIO
- 22 FERRAMENTAS MANUAIS E ELÉCTRICAS
- 23 FITAS DE EMBALAGEM E ESPELHO
- 24 FIXADORES DE PORTADAS DIVERSAS
- 25 FOLHAS SERRA FERRO E ALUMÍNIO
- 26 FREZAS PARA ALUMÍNIO
- 27 KITS PARA CÂMARA EUROPEIA
- 28 MÁQUINAS PARA VIDRO E ALUMÍNIO
- 29 MARCADORES PARA VIDRO E ALUMÍNIO
- 30 MASSAS DE VIDRACEIRO (BETUMES)

Rua Sebastião e Silva, 47/49

2745-838 MASSAMÁ

Tel: 21 439 60 19 - 21 439 42 57/58

Fax: 21 439 60 20

e-mail: EMAIL@MASSAVIDRO.PT



CATÁLOGO

- 31 MÁSTIQUES DIVERSOS (ACRÍLICOS E OUTROS)
- 32 MOLAS DE PAVIMENTO SEVA, AÉREAS E OUTRAS
- 33 MÓS PARA VIDRO
- 34 NADIRES PARA ALUMÍNIO
- 35 ÓLEOS DE SILICONE
- 36 OSILOS BATENTES
- 37 PARAFUSOS ZINCADOS E INOX
- 38 PATERES PARA ALUMÍNIO
- 39 PEÇAS DE PRATELEIRA PARA VIDRO
- 40 PEDRA-POMES
- 41 PELÚCIA VÁRIAS MEDIDAS
- 42 PISTOLAS PARA MÁSTIQUES MANUAIS E HIDRÁULICAS
- 43 POLIDORES PARA VIDRO
- 44 PORCAS DIVERSAS
- 45 PORTAS PAINÉIS DE ALUMÍNIO
- 46 PRIMÁRIOS PARA SILICONES DIVERSOS
- 47 PUXADORES PARA ALUMÍNIO E VIDRO
- 48 REBITES DIVERSOS
- 49 RÉGUAS PARA VIDRO
- 50 RODISIOS PARA CAIXILHARIA DE ALUMÍNIO
- 51 SILICONES NEUTROS, ACÉTICOS (RHODIA, ELCH PRO, SOLYPLAST)
- 52 SPRAY'S DE SILICONE E DE RETOQUE
- 53 SUPORTES PARA ESPELHOS DIVERSOS
- 54 VD GAMA DE VEDANTES PARA CAIXILHARIA DE ALUMÍNIO
- 55 VENTOSAS PARA VIDRO

Rua Sebastião e Silva, 47/49

2745-838 MASSAMÁ

Tel: 21 439 60 19 - 21 439 42 57/58

Fax: 21 439 60 20

e-mail: EMAIL@MASSAVIDRO.PT

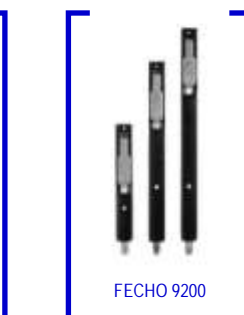

Rua Sebastião e Silva, 47/49

2745-838 MASSAMÁ

Tel: 21 439 60 19 - 21 439 42 57/58

Fax: 21 439 60 20

e-mail: EMAIL@MASSAVIDRO.PT



FECHO 9000



FECHO BASCULANTE 4606



EXTENSOR PARA PATILHA DE CREMONE



PEÇA 504 MR/CE SIMPLES



PEÇA 504 CE DUPLA



ASA 521



CLIP RETENTOR PARA JANELAS 5001



PATER + SAPATA



PUXADOR 957



PUXADOR 958



CANTO ZAMAK 4340



CONJUNTO 104



ESQUADROS EM ALUMINIO INJECTADO



DOBRADIÇA DE PORTA 5040

ASA BOOM



PONTEIRA 510



PONTEIRA 503 CE



PUXADOR 800



PUXADOR 802



PUXADOR 801



FECHO UNHA 205



FECHO CENTRAL 8000



COMPASSO CE

Rua Sebastião e Silva, 47/49

2745-838 MASSAMÁ

Tel: 21 439 60 19 - 21 439 42 57/58

Fax: 21 439 60 20

e-mail: EMAIL@MASSAVIDRO.PT

ACESSÓRIOS CAIXILHARIA

Acessórios MR

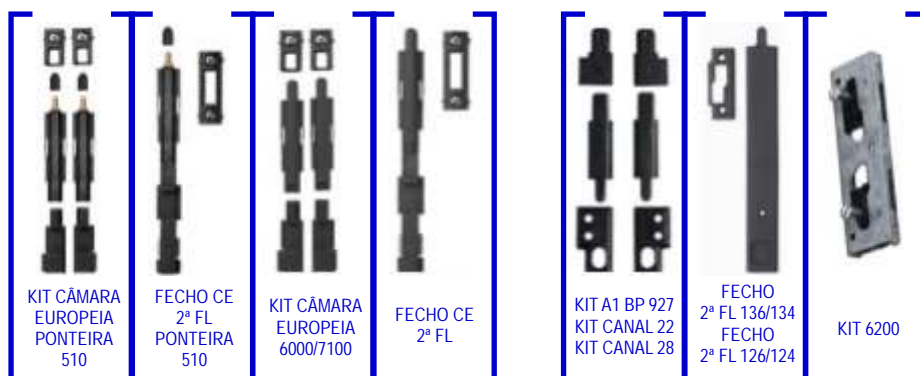

Fecho Lateral de Embutir

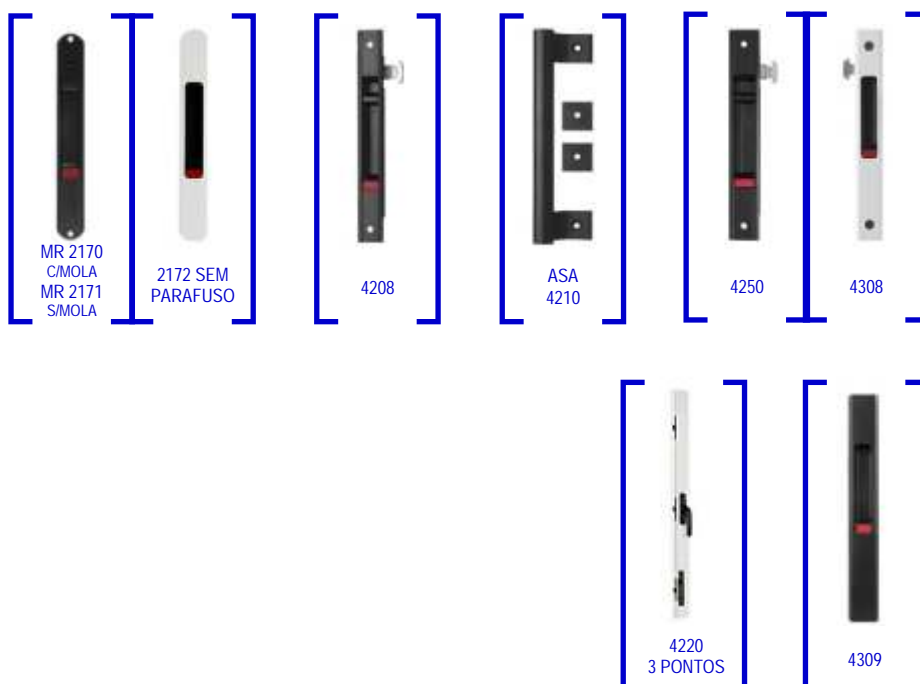

Asas e Puxadores de Porta Inox

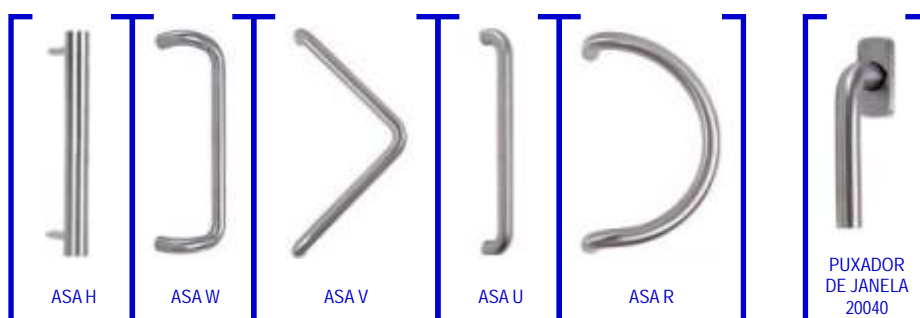

Rua Sebastião e Silva, 47/49

2745-838 MASSAMÁ

Tel: 21 439 60 19 - 21 439 42 57/58

Fax: 21 439 60 20

e-mail: EMAIL@MASSAVIDRO.PT

ACESSÓRIOS CAIXILHARIA

Asas e Puxadores de Porta Inox

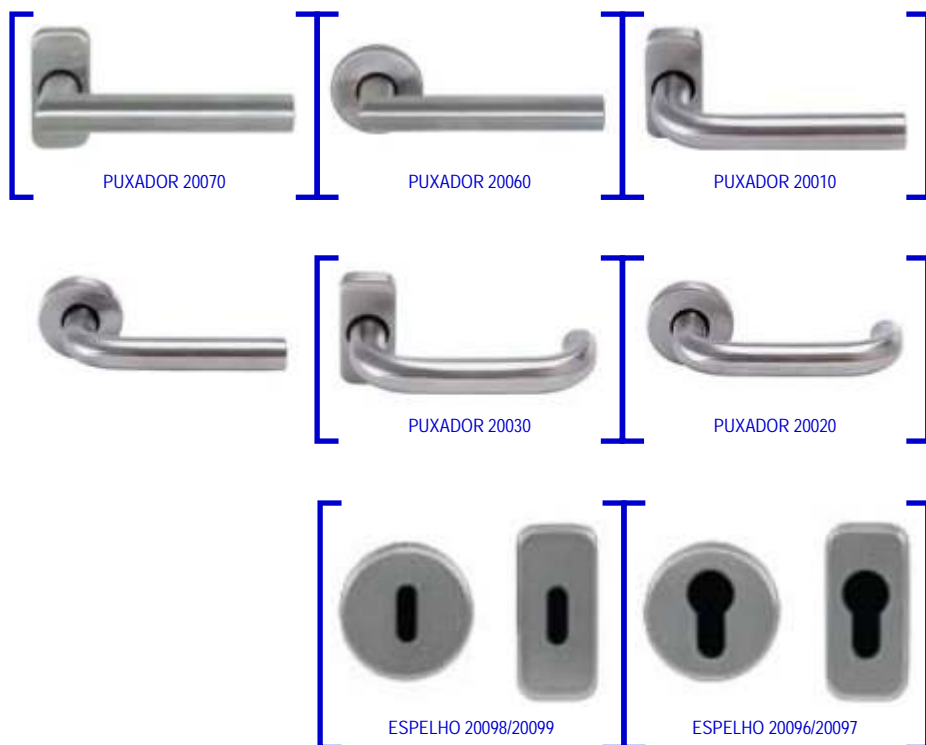

Dobradiças Diversas

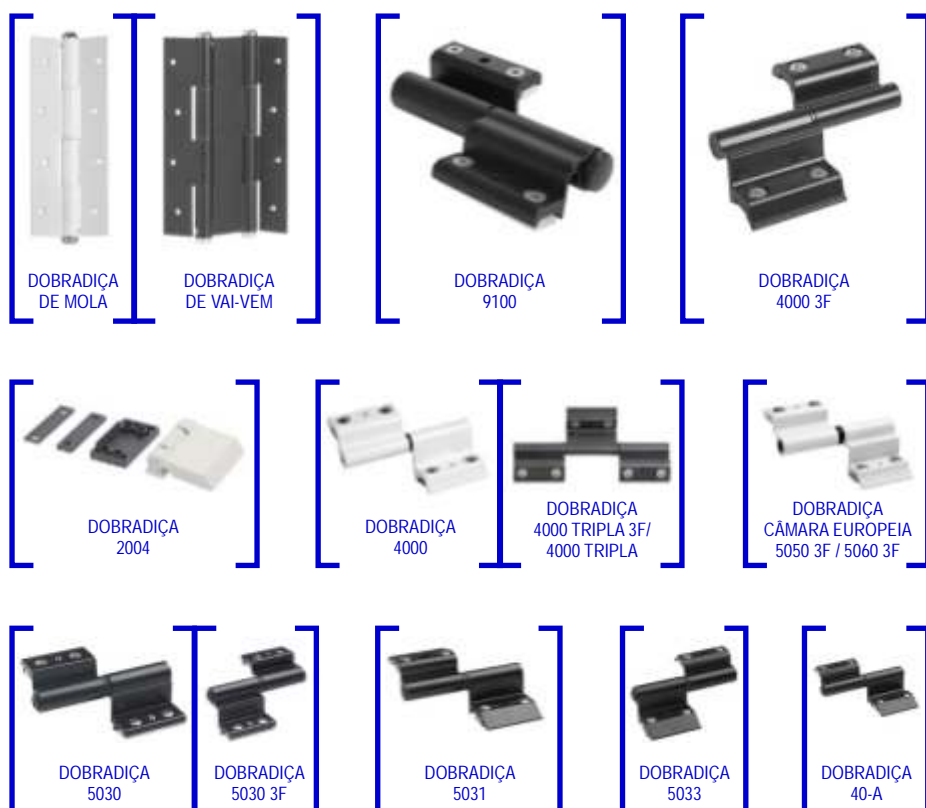

Rua Sebastião e Silva, 47/49

2745-838 MASSAMÁ

Tel: 21 439 60 19 - 21 439 42 57/58

Fax: 21 439 60 20

e-mail: EMAIL@MASSAVIDRO.PT

ACESSÓRIOS CAIXILHARIA

Dobradiças Diversas

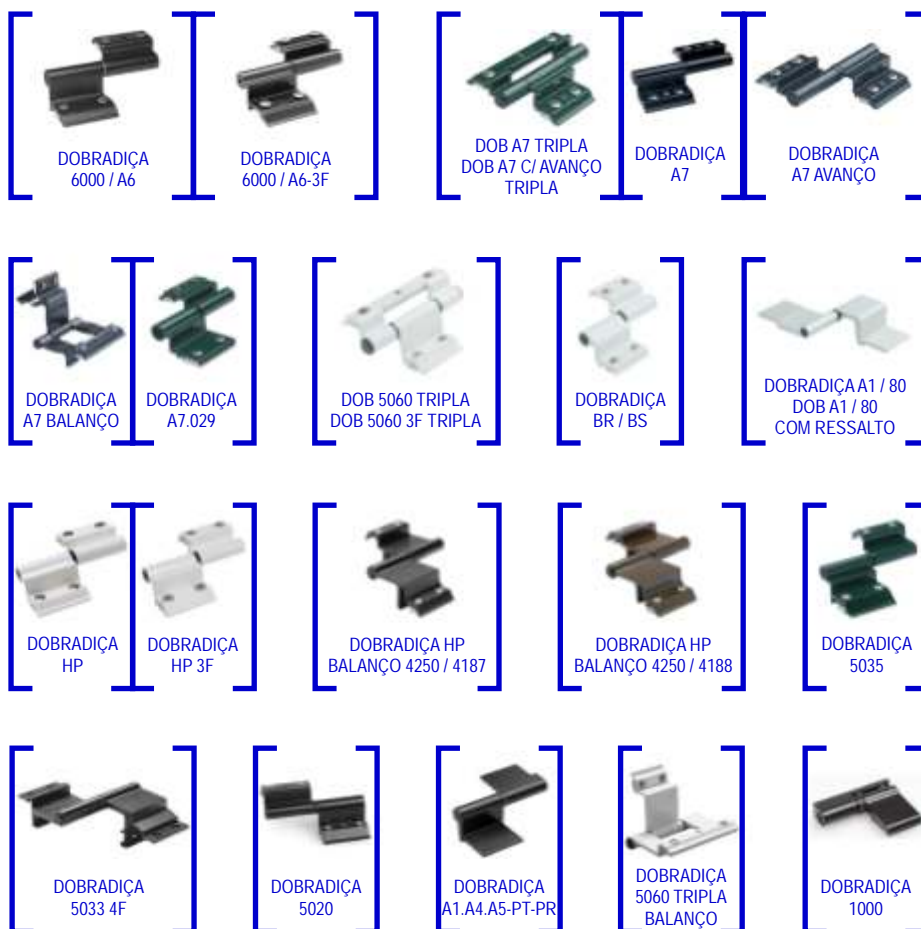

Acessórios Diversos M.R.



Rua Sebastião e Silva, 47/49

2745-838 MASSAMÁ

Tel: 21 439 60 19 - 21 439 42 57/58

Fax: 21 439 60 20

e-mail: EMAIL@MASSAVIDRO.PT

ACESSÓRIOS CAIXILHARIA

Acessórios Diversos M.R.



COMANDO
MANIVELA



COMANDO
ROLLY



COMPASSO
PROJECTANTE

Fechaduras Diversas

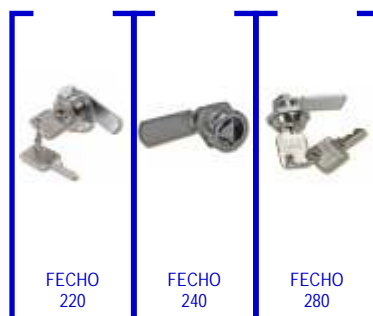

FECHO
220

FECHO
240

FECHO
280



FECHADURA
PRUMO
728 LC

FECHADURA
PRUMO
728 R

FECHADURA
PRUMO
729

FECHADURA
PRUMO
730 SG



FECHADURA
PRUMO
730 SG

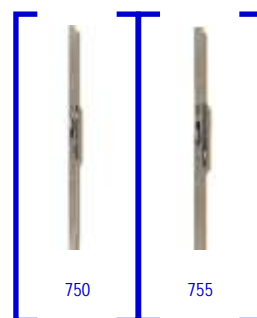

750

755

Esquadros Injectados C.E.

Refª	SÉRIE	MEDIDA (L x H)
0400	BW/PZ/BX	35,9 x 24,0
0410	BXI	23,0 x 14,0
0426	BXI/PZ	27,0 x 31,6
0419		22,0 x 23,5
0404	CX	24,0 x 10,6
0421	BW/BX/PZ/CX BP/A6/BTF	36,0 x 14,0
0406	BW/BX/BP/A6/BTF	36,0 x 30,5
0463	AM	30,5 x 15,5
0464	AM	29,8 x 31,0
0465	A4/BR	26,0 x 10,0
0466	A4/BR	26,0 x 30,0
0417	C-65/JET SLIDE	22,5 x 10,6
0432	C-65/JET SLIDE	41,0 x 10,0
0360	4100 (PORTADA)	36,0 x 19,5
0361	4100 (ARO)	36,0 x 25,5
0362	4100 (FOLHA)	39,0 x 15,4
0402	4100 (ARO)	35,9 x 16,0
0409		28,5 x 14,5
0352	A40	30,0 x 14,5
0437	A40	39,7 x 13,8
1006	A40	41,0 x 31,5
0900	ANGULAR	35,8 x 13,9



Rua Sebastião e Silva, 47/49

2745-838 MASSAMÁ

Tel: 21 439 60 19 - 21 439 42 57/58

Fax: 21 439 60 20

e-mail: EMAIL@MASSAVIDRO.PT

ACESSÓRIOS CAIXILHARIA

Diversos Alfa



REF ^o	DESIGNAÇÃO	UN	QT EMB
409	FECHO DE BANDEIRA	PC	80
501	FUNADOR REDONDO	AVI	10
502	FUNADOR QUADRADO	AVI	10
601	AVI ^o	AVI	1

REF ^o	DESIGNAÇÃO	UN	QT EMB
605	FECHO DE CLAVETA DE 120 mm	PC	20
606	FECHO DE CLAVETA DE 220 mm	PC	20
607	FECHO DE CLAVETA DE 320 mm	PC	20
608	FECHO DE LINA ROÇADO MÓVIL	PC	80
809	FUNADOR DE PORTA COM 385 mm ENTRE FUROS	PC	1
809E	FUNADOR DE PORTA 330 COM 380 mm ENTRE FUROS	PC	1
810	FUNADOR DE PORTA 330 COM 185 mm ENTRE FUROS	PC	1
810E	FUNADOR DE PORTA 330 COM 185 mm ENTRE FUROS	PC	1

	LARGURA MÁXIMA	ALTURA MÁXIMA	PESO MÁXIMO	ÂNGULO DE ABERTURA	DIMENSÃO	REF ^o
	838	1829	52 Kg	90°	500	613
	1200	750	21 Kg	80°	408	609
	1000	1000	24 Kg	50°	510	610
	1636	1321	74 Kg	90°	550	613

REF ^o	DESIGNAÇÃO	UN	QT EMB
050	DECORATIVO DE BICOS	PC	40
051	DECORATIVO DE CARÁOOL	PC	50
052	DECORATIVO LISO	PC	40

CONTACTO ELÉCTRICO

REF^o 611 10 UN/CX

FIXADOR DE PORTADA

	UN	QT EMB
092	PC	100
093	PC	100

DOBRADIÇAS DE 100 mm

COMPASSO/NADIR INVISÍVEL

	UN	QT EMB	AÇO OU LATÃO
612	PAR	20	

Rua Sebastião e Silva, 47/49

2745-838 MASSAMÁ

Tel: 21 439 60 19 - 21 439 42 57/58

Fax: 21 439 60 20

e-mail: EMAIL@MASSAVIDRO.PT

REF ^o	DESIGNAÇÃO	UN	QT. EMB
401	CREMONE ROMANA C/AVEN ROSCADO MI	PC	20
402	CREMONE ROMANA DE SARGO	PC	20
403	CREMONE DE ALUMINIO DE SARGO	PC	20
404	CREMONE DE PORTUGA	PC	20
405	CREMONE DE ALUMINIO C/AVEN ROSCADO MI	PC	20
406	CREMONE DE ALUMINIO DE SARGO	PC	20
408A	CREMONE DE LANGUEN	PC	20
409	FECHO DE BANDEJA	PC	50
501	PARADOR REDONDO	PAR	10
502	PARADOR QUADRADO	PAR	10
607	PISTOL	PAR	1

REF ^o	DESIGNAÇÃO	QT. EMB
203	FECHO CENTRAL	100 PC
213	FECHO CENTRAL	100 PC
214	FECHO LATERAL - P/ROTE	100 PC
237	FECHO DE EMBELE ESTAVO - JANELA INCLINADO	30 PC
236	FECHO DE EMBELE ESTAVO - JANELA INCLINADO	30 PC
200	PARADOR P/REFP 237/236/207/206	20 PC

REF^o 702
ESQUADRO
DE ALUMINIO
QT. EMB 150

REF^o 703
ESQUADRO
DE ALUMINIO
QT. EMB 100

REF^o 701
ESQUADRO
DE AÇO
QT. EMB 200

REF^o 720
CHAVE SERRADA
4 mm
3 mm
10 UNIDK

REF^o K1

LARGURAS

	1	2	3	4	5	6	7	
	26,7	30,6	32,2	34,2	36,2	26,0	29,5	
ALTURAS	A	A1	A2	A3	A4		A6	A7
	B	B1		B3	B4	B5		
	C	C1		C3	C4	C5		
	D				D4			
	E	E1	E2	E3	E4	E5	E6	E7
	F				F4			
		17,5						
	14,0							
	10,5							

Cremones Alualpha

KIT OSCILO
BATENTE

CREMONE
MILL ROT
540

CREMONE
MILL ROT
520

CREMONE
MILL ROT
510

CREMONE
MILL ROT
512

CREMONE
MILL ROT
BAIXA 533

CREMONE
MILL ROT
BAIXA 530

CREMONE
MILL ROT
BAIXA 532

CREMONE
MILL LINGUETA
507

CREMONE MILL
SEGURANÇA
580

CREMONE MILL
SEGURANÇA
570

CREMONE
REFLEX ROT
440

CREMONE
REFLEX ROT
420

Rua Sebastião e Silva, 47/49

2745-838 MASSAMÁ

Tel: 21 439 60 19 - 21 439 42 57/58

Fax: 21 439 60 20

e-mail: EMAIL@MASSAVIDRO.PT

ACESSÓRIOS CAIXILHARIA

Cremones Alualpha



Cremones com Chave

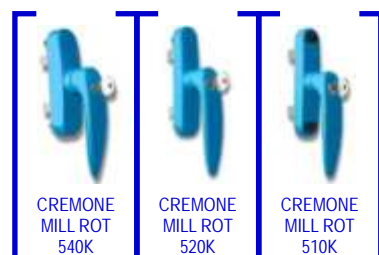

Muletas



Rua Sebastião e Silva, 47/49

2745-838 MASSAMÁ

Tel: 21 439 60 19 - 21 439 42 57/58

Fax: 21 439 60 20

e-mail: EMAIL@MASSAVIDRO.PT

ACESSÓRIOS CAIXILHARIA

Fecho de Bandeira



FECHO DE BANDEIRA
509 - R

FECHO DE BANDEIRA
509

Caixa de Correio



CAIXA DE CORREIO
UMA OU DUAS FRENTES

Fechos de Embutir



REF
246 P

REF
247 P

REF
245 P

REF
249

REF
259

REF
257

REF 244
C/ CONCHA

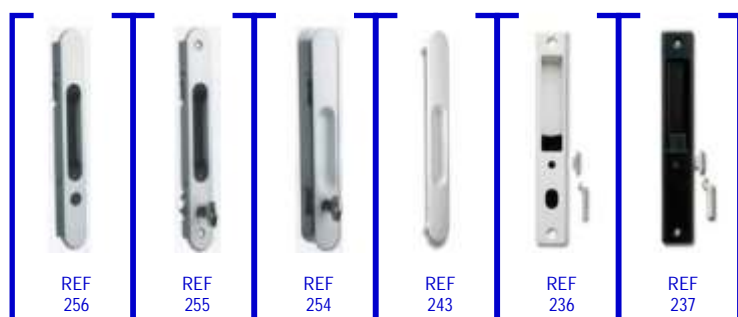

REF
256

REF
255

REF
254

REF
243

REF
236

REF
237

Rua Sebastião e Silva, 47/49

2745-838 MASSAMÁ

Tel: 21 439 60 19 - 21 439 42 57/58

Fax: 21 439 60 20

e-mail: EMAIL@MASSAVIDRO.PT

ACESSÓRIOS CAIXILHARIA

Fechos Diversos



ASA FECHO
200

FECHO
CENTRAL

FECHO 2ª FOLHA
2F - AT

FECHO 2ª
FOLHA 2F

Puxadores

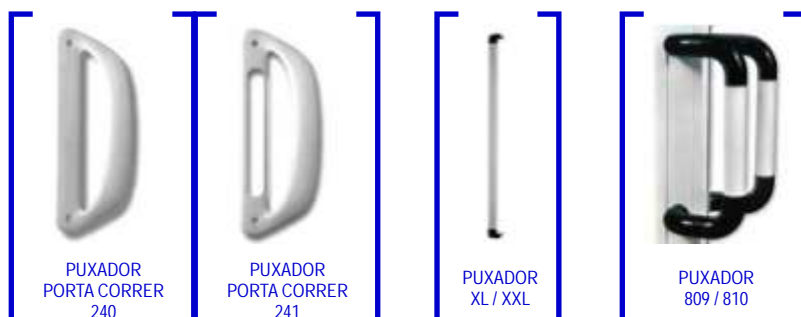

PUXADOR
PORTA CORRER
240

PUXADOR
PORTA CORRER
241

PUXADOR
XL / XXL

PUXADOR
809 / 810

Compasso Basculante

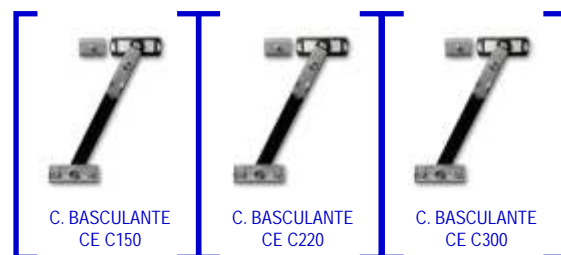

C. BASCULANTE
CE C150

C. BASCULANTE
CE C220

C. BASCULANTE
CE C300

Kits



KIT
33005

KIT
33006

KIT
33007

KIT
33008

KIT
33009

Rua Sebastião e Silva, 47/49

2745-838 MASSAMÁ

Tel: 21 439 60 19 - 21 439 42 57/58

Fax: 21 439 60 20

e-mail: EMAIL@MASSAVIDRO.PT

ACESSÓRIOS CAIXILHARIA

Dobradiças C.E.

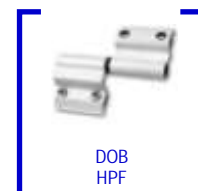
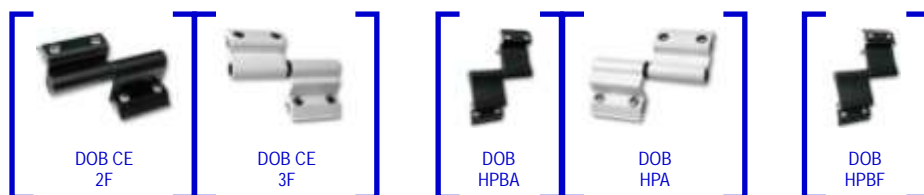

Frentes e Caixas de Correio DUBRAL

Homologados pelos CTT - Vários Acabamentos



Rua Sebastião e Silva, 47/49

2745-838 MASSAMÁ

Tel: 21 439 60 19 - 21 439 42 57/58

Fax: 21 439 60 20

e-mail: EMAIL@MASSAVIDRO.PT

ACESSÓRIOS CAIXILHARIA

Sistema Persianas Móveis DUBRAL



MAXI }
MINI } 54
PZ }



MAXI }
MINI } 55
PZ }



MAXI }
MINI } 70
PZ }

Designação do Acessório	Altura Máxima	Altura Mínima	Comprimento (Largura)
7888	328		MASSAVIDRO 54 03
QUATRO	330		MASSAVIDRO 54 04
8888	336		MASSAVIDRO 54 05
888	408		MASSAVIDRO 54 06
8888	468		MASSAVIDRO 54 07
870	516		MASSAVIDRO 54 08
870C	570		MASSAVIDRO 54 09
888	624		MASSAVIDRO 54 10
8888	678		MASSAVIDRO 54 11
8888	732		MASSAVIDRO 54 12
7888	786		MASSAVIDRO 54 13
QUATRO	840		MASSAVIDRO 54 14
8888	894		MASSAVIDRO 54 15
88888888	948		MASSAVIDRO 54 16
88888888	1002		MASSAVIDRO 54 17
88888888	1056		MASSAVIDRO 54 18
88888888	1110		MASSAVIDRO 54 19
VITE*	1164		MASSAVIDRO 54 20
VITE E LIX	1218		MASSAVIDRO 54 21
VITE E 8888	1272		MASSAVIDRO 54 22
VITE E 7888	1326		MASSAVIDRO 54 23
VITE E QUATRO	1380		MASSAVIDRO 54 24
VITE E 8888	1434		MASSAVIDRO 54 25
VITE E 888	1488		MASSAVIDRO 54 26
VITE E 888	1542		MASSAVIDRO 54 27
VITE E 888	1596		MASSAVIDRO 54 28
VITE E 888	1650		MASSAVIDRO 54 29
TESTA	1704		MASSAVIDRO 54 30
TESTA E LIX	1758		MASSAVIDRO 54 31
TESTA E 8888	1812		MASSAVIDRO 54 32
TESTA E 7888	1866		MASSAVIDRO 54 33
TESTA E QUATRO	1920		MASSAVIDRO 54 34
TESTA E 8888	1974		MASSAVIDRO 54 35
TESTA E 888	2028		MASSAVIDRO 54 36
TESTA E 888	2082		MASSAVIDRO 54 37
TESTA E 888	2136		MASSAVIDRO 54 38
TESTA E 8888	2190		MASSAVIDRO 54 39

Designação do Acessório	Altura Máxima	Altura Mínima	Comprimento (Largura)
7888	372		MASSAVIDRO 55 03
QUATRO	374		MASSAVIDRO 55 04
8888	380		MASSAVIDRO 55 05
888	432		MASSAVIDRO 55 06
888	480		MASSAVIDRO 55 07
888	540		MASSAVIDRO 55 08
8888	600		MASSAVIDRO 55 09
888	655		MASSAVIDRO 55 10
8888	710		MASSAVIDRO 55 11
8888	765		MASSAVIDRO 55 12
7888	820		MASSAVIDRO 55 13
QUATRO	875		MASSAVIDRO 55 14
8888	930		MASSAVIDRO 55 15
88888888	985		MASSAVIDRO 55 16
88888888	1040		MASSAVIDRO 55 17
88888888	1095		MASSAVIDRO 55 18
88888888	1150		MASSAVIDRO 55 19
VITE*	1205		MASSAVIDRO 55 20
VITE E LIX	1260		MASSAVIDRO 55 21
VITE E 8888	1315		MASSAVIDRO 55 22
VITE E 7888	1370		MASSAVIDRO 55 23
VITE E QUATRO	1425		MASSAVIDRO 55 24
VITE E 8888	1480		MASSAVIDRO 55 25
VITE E 888	1535		MASSAVIDRO 55 26
VITE E 888	1590		MASSAVIDRO 55 27
VITE E 888	1645		MASSAVIDRO 55 28
TESTA	1700		MASSAVIDRO 55 29
TESTA E LIX	1755		MASSAVIDRO 55 30
TESTA E 8888	1810		MASSAVIDRO 55 31
TESTA E 7888	1865		MASSAVIDRO 55 32
TESTA E QUATRO	1920		MASSAVIDRO 55 33
TESTA E 8888	1975		MASSAVIDRO 55 34
TESTA E 888	2030		MASSAVIDRO 55 35
TESTA E 888	2085		MASSAVIDRO 55 36
TESTA E 888	2140		MASSAVIDRO 55 37
TESTA E 888	2195		MASSAVIDRO 55 38
TESTA E 8888	2250		MASSAVIDRO 55 39

Designação do Acessório	Altura Máxima	Comprimento (Largura)
7888	388	MASSAVIDRO 70 03
QUATRO	390	MASSAVIDRO 70 04
8888	402	MASSAVIDRO 70 05
888	420	MASSAVIDRO 70 06
888	528	MASSAVIDRO 70 07
870	606	MASSAVIDRO 70 08
870C	645	MASSAVIDRO 70 09
888	720	MASSAVIDRO 70 10
8888	798	MASSAVIDRO 70 11
8888	822	MASSAVIDRO 70 12
7888	882	MASSAVIDRO 70 13
QUATRO	948	MASSAVIDRO 70 14
8888	1020	MASSAVIDRO 70 15
88888888	1056	MASSAVIDRO 70 16
88888888	1128	MASSAVIDRO 70 17
88888888	1188	MASSAVIDRO 70 18
88888888	1260	MASSAVIDRO 70 19
VITE*	1320	MASSAVIDRO 70 20
VITE E LIX	1380	MASSAVIDRO 70 21
VITE E 8888	1440	MASSAVIDRO 70 22
VITE E 7888	1488	MASSAVIDRO 70 23
VITE E QUATRO	1548	MASSAVIDRO 70 24
VITE E 8888	1608	MASSAVIDRO 70 25
VITE E 888	1668	MASSAVIDRO 70 26
VITE E 888	1728	MASSAVIDRO 70 27
VITE E 888	1788	MASSAVIDRO 70 28
VITE E 888	1848	MASSAVIDRO 70 29
TESTA	1908	MASSAVIDRO 70 30
TESTA E LIX	1968	MASSAVIDRO 70 31
TESTA E 8888	2028	MASSAVIDRO 70 32
TESTA E 7888	2088	MASSAVIDRO 70 33
TESTA E QUATRO	2148	MASSAVIDRO 70 34
TESTA E 8888	2208	MASSAVIDRO 70 35
TESTA E 888	2268	MASSAVIDRO 70 36
TESTA E 888	2328	MASSAVIDRO 70 37
TESTA E 8888	2388	MASSAVIDRO 70 38
TESTA E 8888	2448	MASSAVIDRO 70 39

Fechaduras para Alumínio GNS







FECHADURA
3 PONTOS
COM CILINDRO
7799
TESTA U OU LISA



FECHADURA
3 PONTOS
C/ CHAVE CRUZ
7796
TESTA U OU LISA



7797



7797 G



7797 R



7797 T



7797 L

Rua Sebastião e Silva, 47/49
 2745-838 MASSAMÁ
 Tel: 21 439 60 19 - 21 439 42 57/58
 Fax: 21 439 60 20
 e-mail: EMAIL@MASSAVIDRO.PT

ACESSÓRIOS CAIXILHARIA

Fechaduras para Alumínio GNS

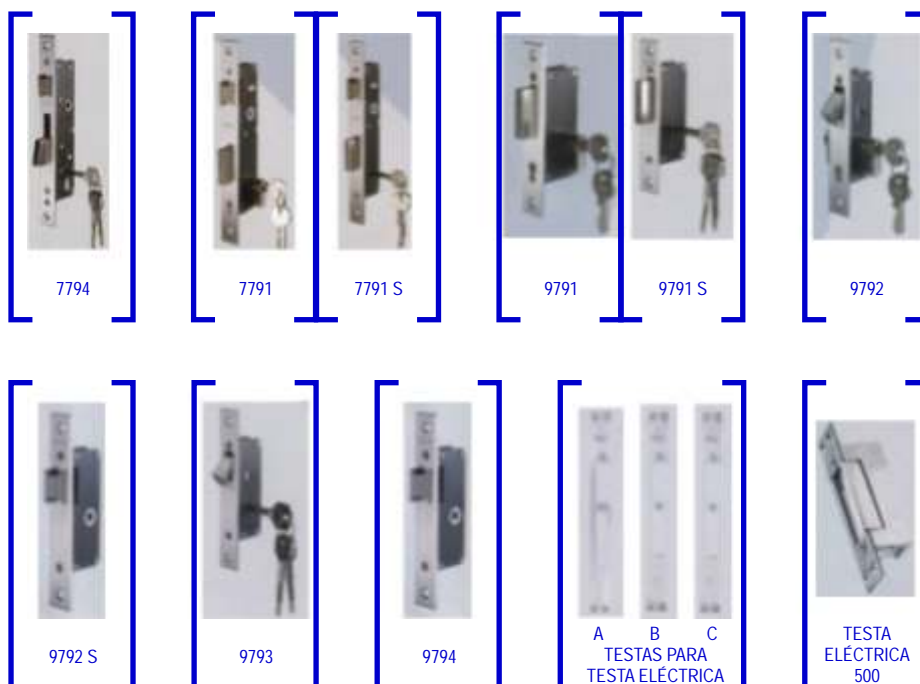

Cremones GNS



Rua Sebastião e Silva, 47/49

2745-838 MASSAMÁ

Tel: 21 439 60 19 - 21 439 42 57/58

Fax: 21 439 60 20

e-mail: EMAIL@MASSAVIDRO.PT

ACESSÓRIOS CAIXILHARIA

Acessórios Diversos GNS



ESPELHO
3500



KIT
3200



KIT
3250



KIT
C.E. 2000



COMPASSO
C.E. 5000



COMPASSO
PORTADA 3400



FECHO
EMBUTIR 3000



FECHO
2200



FECHO
A-040



TERMINAIS SIMPLES
E TERMINAIS BAIXOS



TERMINAIS
DUPLOS



A B
PONTEIRAS



TAPA
POROS

Barras Anti-Pânico FEB/OMEK

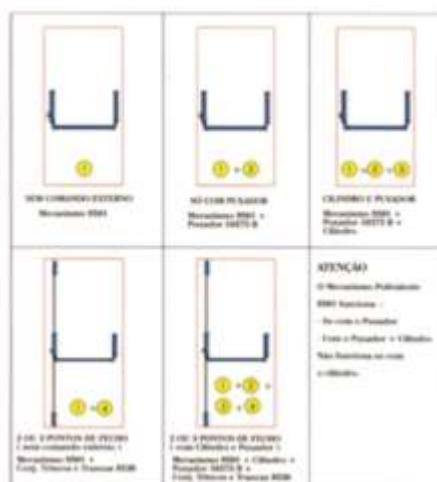

Rua Sebastião e Silva, 47/49

2745-838 MASSAMÁ

Tel: 21 439 60 19 - 21 439 42 57/58

Fax: 21 439 60 20

e-mail: EMAIL@MASSAVIDRO.PT

ACESSÓRIOS CAIXILHARIA

Fechos SOFI

sofi[®]



FECHO 9521
C/ CHAVE

FECHO 10800

FECHO 10800
C/ CHAVE

FECHO 11315

FECHO 11338
C/ CHAVE

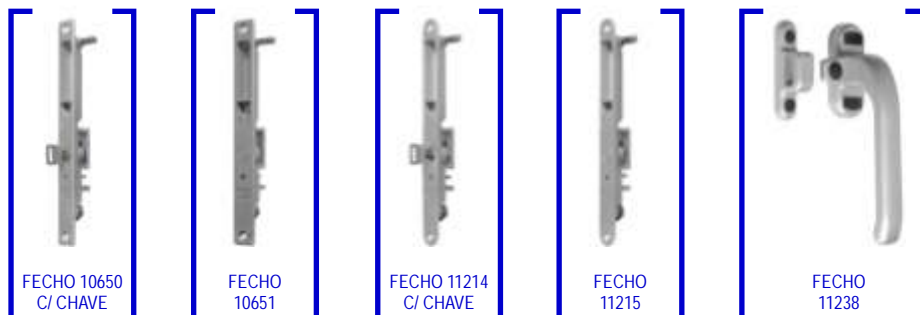

FECHO 10650
C/ CHAVE

FECHO 10651

FECHO 11214
C/ CHAVE

FECHO 11215

FECHO 11238

Cremones SOFI

sofi[®]



CREMONE 10751

CREMONE 10753

CREMONE 10768

CREMONE 11239-E
C/ CHAVE

CREMONE 11240
C/ CHAVE

Fechaduras SOFI

sofi[®]

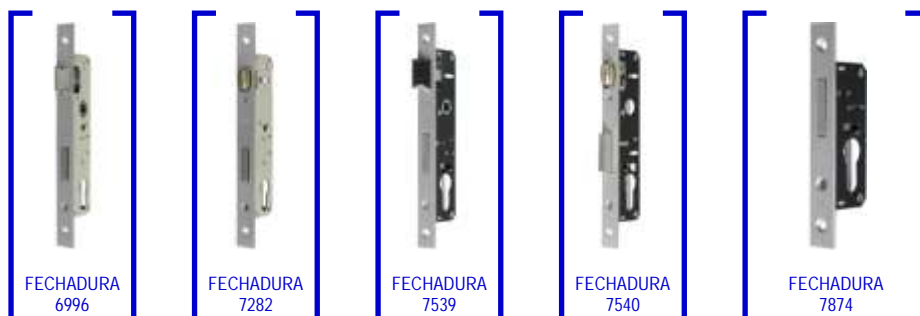

FECHADURA 6996

FECHADURA 7282

FECHADURA 7539

FECHADURA 7540

FECHADURA 7874

Rua Sebastião e Silva, 47/49

2745-838 MASSAMÁ

Tel: 21 439 60 19 - 21 439 42 57/58

Fax: 21 439 60 20

e-mail: EMAIL@MASSAVIDRO.PT

ACESSÓRIOS CAIXILHARIA

Fechaduras SOFI



FECHADURA
9596



FECHADURA
9626



FECHADURA
10267



FECHADURA
8416

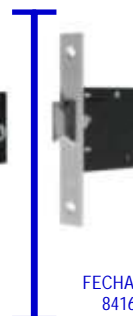

FECHADURA
8416.21



FECHADURA
TUBULAR

Cilindros para Fechaduras



CILINDRO
8586



CILINDRO
10769



CILINDRO
7756

Puxadores de Porta



PUXADOR DE PORTA
11201



PUXADOR DE PORTA
11204



PUXADOR DE PORTA
11196



PUXADOR DE PORTA
10665



PUXADOR DE PORTA
10666



PUXADOR DE PORTA
10963



PUXADOR DE PORTA
11181

Rua Sebastião e Silva, 47/49

2745-838 MASSAMÁ

Tel: 21 439 60 19 - 21 439 42 57/58

Fax: 21 439 60 20

e-mail: EMAIL@MASSAVIDRO.PT

ACESSÓRIOS CAIXILHARIA

Puxadores de Porta



PUXADOR
11202



PUXADOR
11066



PUXADOR
10876



PUXADOR
10961

Janela Basculante



FECHO BANDEIRA
11216

Janela Projectante



COMPASSO
PROJECTANTE
11256



COMPASSO
PROJECTANTE
11257

Fechaduras FEB / OMEC / GNS



FEB
7300 / 7301
OMEC
1570 / 1175



FEB
7305 / 7306
OMEC
4570 / 4175



FECHADURA
5815



FECHADURA
5820



FECHADURA
7611 P

Rua Sebastião e Silva, 47/49

2745-838 MASSAMÁ

Tel: 21 439 60 19 - 21 439 42 57/58

Fax: 21 439 60 20

e-mail: EMAIL@MASSAVIDRO.PT

ACESSÓRIOS CAIXILHARIA

Fechaduras FEB / OMEC / GNS



FECHADURA
1611 PCK



FECHADURA
6993



FECHADURA
7613



FECHADURA
7613 PCK



FECHADURA
5805

Trincos Eléctricos CISA / FEB / FIAM



FECHADURA
5002

Fechaduras Alta Segurança CISA / FEB



FECHADURA
7200/40



FECHADURA
7230/40



FECHADURA
8230

Rua Sebastião e Silva, 47/49

2745-838 MASSAMÁ

Tel: 21 439 60 19 - 21 439 42 57/58

Fax: 21 439 60 20

e-mail: EMAIL@MASSAVIDRO.PT

ACESSÓRIOS CAIXILHARIA

Diversos POLISMAR



FECHO
LATERAL



TELEFONE

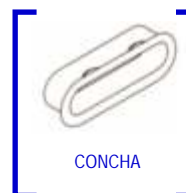

CONCHA



FIXADOR PORTADAS
2 FOLHAS



FIXADOR PORTADAS
1 FOLHA



TAMPA
PATERE



CALÇO
ARO



CALÇO
VIDRO



TAPAFUROS
CO / CX



CHAPA
TESTA



CONJUNTO CHAPA
TESTA DUPLA



ESPELHO
FECHADURA



CONJUNTO
CONTACTO DE PORTA

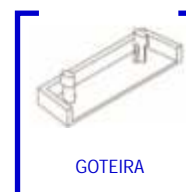

GOTEIRA

Rodízios Diversos



RODÍZIO
SÉRIE PF 90



RODÍZIO
SÉRIE PF 70



RODÍZIO
SÉRIE BANHEIROS



RODÍZIO
SÉRIE SW



RODÍZIO
SÉRIE B05



RODÍZIO
SÉRIE SR



RODÍZIO
MINI



RODÍZIO
CR



RODÍZIO
SG

Rua Sebastião e Silva, 47/49

2745-838 MASSAMÁ

Tel: 21 439 60 19 - 21 439 42 57/58

Fax: 21 439 60 20

e-mail: EMAIL@MASSAVIDRO.PT

ACESSÓRIOS CAIXILHARIA

Diversos POLISMAR

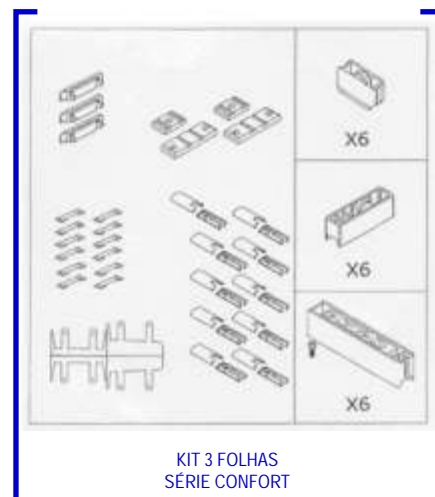
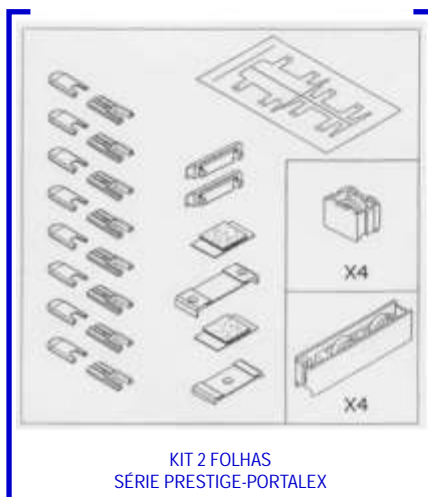
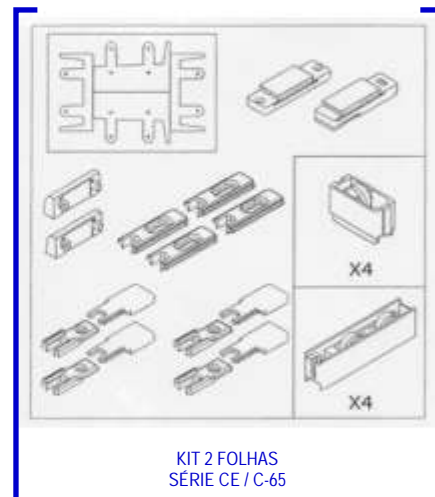
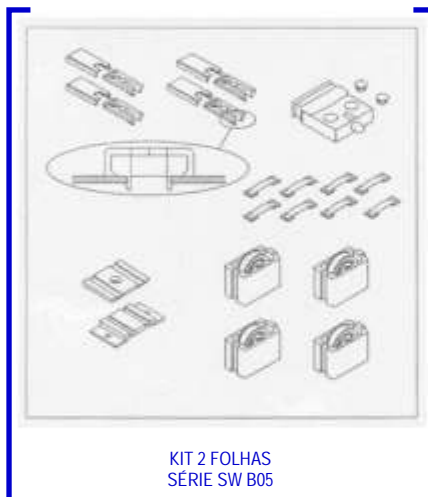
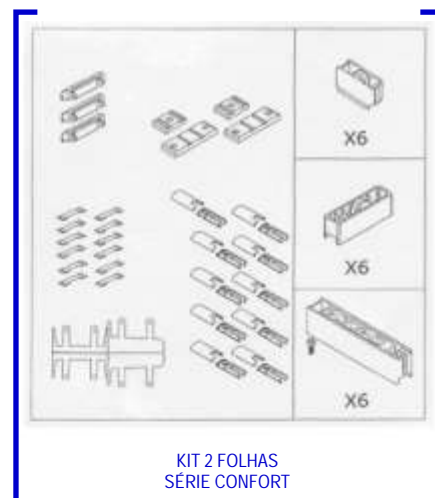

Rua Sebastião e Silva, 47/49

2745-838 MASSAMÁ

Tel: 21 439 60 19 - 21 439 42 57/58

Fax: 21 439 60 20

e-mail: EMAIL@MASSAVIDRO.PT

ACESSÓRIOS CAIXILHARIA

Sprays Diversos



Sprays / Pincéis de Retoques



Rua Sebastião e Silva, 47/49

2745-838 MASSAMÁ

Tel: 21 439 60 19 - 21 439 42 57/58

Fax: 21 439 60 20

e-mail: EMAIL@MASSAVIDRO.PT



01. Juntas Sanitárias, Polibans Acrílicos
02. Juntas Sanitárias, Casa de Banho e Cozinhas
03. Colagem em Espelhos
04. Juntas Cerâmicas
05. Impermeabilização de Telhados
06. Calafetagem de Tubos de Evacuação
07. Estanquicidade e Colagem de Algerozes
08. Reparação de Fissuras
09. Protecção Contra Infiltrações
10. Selagem de Caixilharia de Madeira, Alumínio e PVC
11. Construção de Aquários
12. Colagem de Parquet
13. Colagem de Telhas e Elementos de Suporte do Telhado
14. Reparação "urgentes" em Telhados
15. Juntas e Colagens Diversas sobre Vidro
16. Juntas em Cozinhas
17. Juntas de Alta Temperatura
18. Juntas de Drenagem e Piscinas
19. Colagem de Alta Resistência

Rua Sebastião e Silva, 47/49

2745-838 MASSAMÁ

Tel: 21 439 60 19 - 21 439 42 57/58

Fax: 21 439 60 20

e-mail: EMAIL@MASSAVIDRO.PT



CONSTRUÇÃO

- CONSTRUÇÃO
- MARCENARIA
- ACRÍLICO EDIFÍCIO
- ACRÍLICO REBOCO
- ACRÍLICO MULTIUSOS
- ESPUMA POLIURETANO
- SPRAY LIMPEZA
- ESPUMA POLIURETANO
- SERRALHARIA - METALURGIA
- PEDRA MÁRMORE
- POLIURETANO EDIFÍCIO



COBERTURAS

- REVETO'IL E30
- REVETO'SIL P40
- TELHADOS COBERTURA
- TELHADOS ZINCO
- ANTI-FUGAS URGENTE



SANITÁRIOS

- SANITÁRIO
- SANITÁRIO NEUTRO C/ FUNGICIDA
- SANITÁRIO NOVA GERAÇÃO
- DISSOLVENTE JUNTAS DE SILICONE



ESPELHOS - VIDROS

- VIDROS
- ESPELHOS
- CRISTAL



DECORAÇÃO

- COLA ALTA POTÊNCIA
- COLA PARQUET
- COLA PVC
- COLA CONTACTO
- COLA FIXAÇÃO
- COLA CIANOCRILATO



ESPECIALIDADES TÉCNICAS

- ESPUMA POLIURETANO ANTI-FOGO
- COLA POLIURETANO ALTA RESISTÊNCIA
- SILICONE AQUÁRIO
- SILICONE CORTA-FOGO
- SILICONE ALTA TEMPERATURA

Rua Sebastião e Silva, 47/49

2745-838 MASSAMÁ

Tel: 21 439 60 19 - 21 439 42 57/58

Fax: 21 439 60 20

e-mail: EMAIL@MASSAVIDRO.PT

SILICONES ELCH PRO Sanitário



ANTIGO 3S / 3E

APLICAÇÕES:
JUNTAS DE CASA DE BANHO, COZINHAS, ETC.

VANTAGENS DO PRODUTO:
1. ANTI-FUNGOS (FUNGICIDA FORTE).
2. ADERE PERFEITAMENTE SOBRE SUPERFÍCIES LISAS.
3. RESISTENTE A ABRASIVOS E AGRESSÕES QUÍMICAS (PRODUTOS DE LIMPEZA, DETERGENTES).
4. RETICULA RÁPIDO E FICA COM ASPECTO BRILHANTE.

CORES DISPONÍVEIS:
TRANSPARENTE, BRANCO

ACONDICIONAMENTO:
310 ML (CX 25 UNID)

Serralharia Metalurgica



ANTIGO 3S / 3E

APLICAÇÕES:
ESPECIALMENTE CONCEBIDO PARA APLICAÇÃO NOS SEGUINTE DOMÍNIOS: SERRALHARIA, METALURGIA (CALAFETAMENTO DE JANELAS, VARANDAS,...) ARRANJOS/DECORAÇÃO, JUNTAS DE VIDROS.

VANTAGENS DO PRODUTO:
1. SECAGEM FÁCIL
2. EXCELENTE ADERÊNCIA ÀS SUPERFÍCIES LISAS NÃO POROSAS
3. EXCELENTE RESISTÊNCIA ÀS DIVERSAS AGRESSÕES (TEMPERATURA, CHUVA UV, PRODUTOS QUÍMICOS)
4. GRANDE ESCOLHA DE CORES (ASPECTO BRILHANTE)
5. PRESENÇA ANTI FUNGICIDA (C/FUNGICIDA)

CORES DISPONÍVEIS:
ALUMÍNIO, TRANSLÚCIDO, CINZENTO, BRANCO, CASTANHO,

ACONDICIONAMENTO:
310 ML (CX 25 UNID)

Silicone 7T



APLICAÇÕES:
CONSTRUÇÃO, JUNTAS DE LIGAÇÃO PARA TODOS OS MATERIAIS, JUNTAS DE DILATAÇÃO, DE RUPTURA E CALAFETAGEM, JUNTAS PERIMÉTRICAS DE JANELAS, ALUMÍNIO, MADEIRA, PVC, CARAVANAS, JUNTAS DE COLAGEM DE MATERIAIS SUBMETIDOS A VIBRAÇÕES.

VANTAGENS DO PRODUTO:
1. EXCELENTE ADERÊNCIA SOBRE TODOS OS SUPORTES SEM PRIMÁRIO (INCLUINDO PMMA, PVC, POLICARBONATOS).
2. SATISFAZ AS NORMAS DO OFÍCIO (ETIQUETADO CNJF: ELASTÓMERO 1ª CATEGORIA).
3. DURABILIDADE EXCEPCIONAL
4. BOA ELASTICIDADE.
5. FÁCIL UTILIZAÇÃO (EXTRUSÃO E ALISAMENTO FÁCIL).

CORES DISPONÍVEIS:
TRANSPARENTE E BRANCO

ACONDICIONAMENTO: 310 ML (CX 25 UNID)

Rua Sebastião e Silva, 47/49

2745-838 MASSAMÁ

Tel: 21 439 60 19 - 21 439 42 57/58

Fax: 21 439 60 20

e-mail: EMAIL@MASSAVIDRO.PT

Silicone 7B: Colagem de Espelhos (Neutro)



APLICAÇÕES:

COLAGEM DE ESPELHOS, SILICONE EXTREMAMENTE BRANDO EM MATERIAIS SENSÍVEIS TAIS COMO MÁRMORES E GRANITOS

VANTAGENS DO PRODUTO:

1. DURABILIDADE EXCEPCIONAL
2. BOA ELASTICIDADE
3. FÁCIL UTILIZAÇÃO

CORES DISPONÍVEIS:

TRANSPARENTE

ACONDICIONAMENTO:

310 ML (CX 25 UNID)

Rua Sebastião e Silva, 47/49

2745-838 MASSAMÁ

Tel: 21 439 60 19 - 21 439 42 57/58

Fax: 21 439 60 20

e-mail: EMAIL@MASSAVIDRO.PT

VEDANTES DE BORRACHA

E.P.D.M. Camada Europeia - Tradicional

Vedantes para Caixilharia de Alumínio de Correr

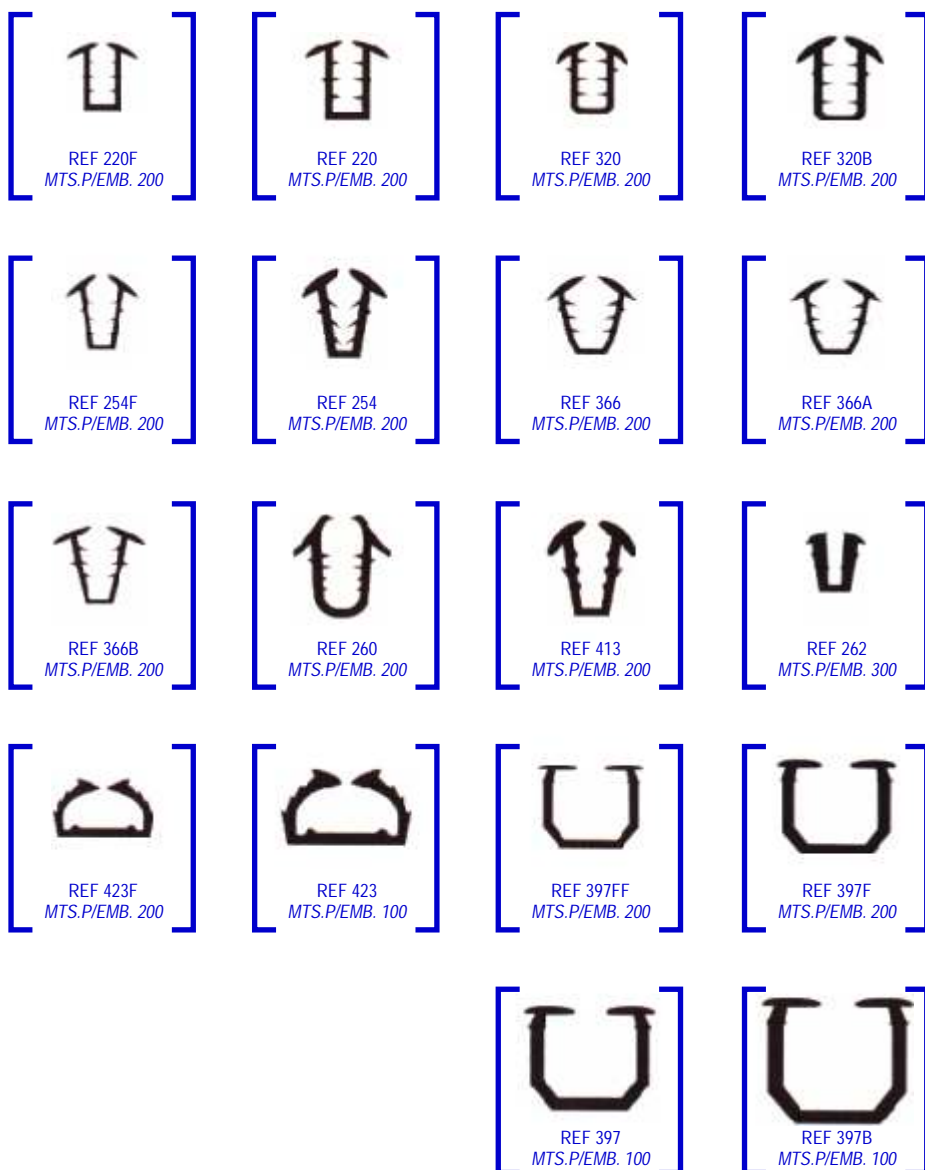

Rua Sebastião e Silva, 47/49

2745-838 MASSAMÁ

Tel: 21 439 60 19 - 21 439 42 57/58

Fax: 21 439 60 20

e-mail: EMAIL@MASSAVIDRO.PT

VEDANTES DE BORRACHA

E.P.D.M. Camada Europeia - Tradicional

Vedantes para Caixilharia de Alumínio de Correr

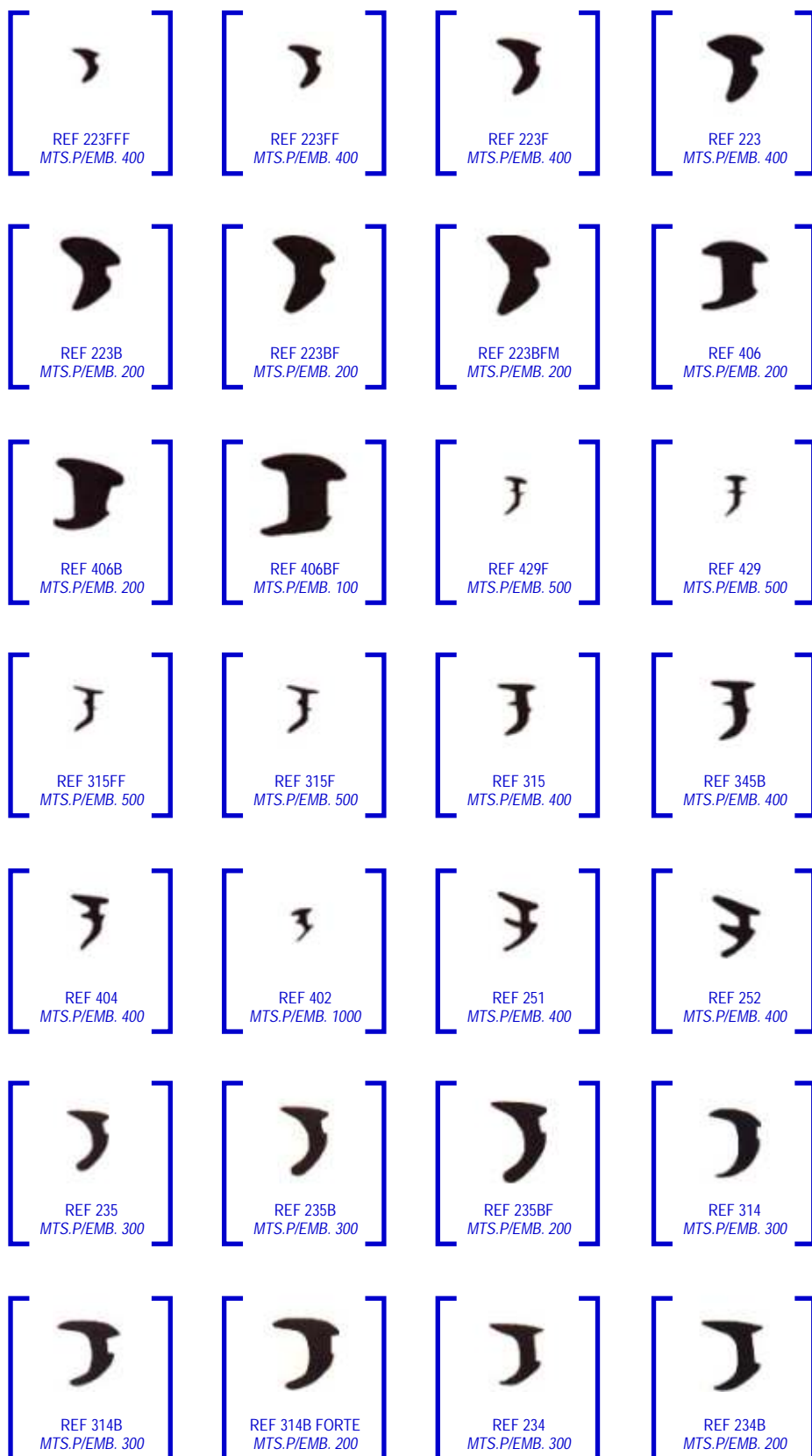

Rua Sebastião e Silva, 47/49

2745-838 MASSAMÁ

Tel: 21 439 60 19 - 21 439 42 57/58

Fax: 21 439 60 20

e-mail: EMAIL@MASSAVIDRO.PT

MOLAS DE PAVIMENTO "SEVAX" E OUTRAS



MOLA
SEVAX TS90

Tampas



TAMPAS
INOX / LATÃO ECOFERM



TAMPAS
INOX / LATÃO T590

Braço



BRAÇO
BATENTE



BRAÇO
VAI-VEM

Rua Sebastião e Silva, 47/49

2745-838 MASSAMÁ

Tel: 21 439 60 19 - 21 439 42 57/58

Fax: 21 439 60 20

e-mail: EMAIL@MASSAVIDRO.PT



MOLA "SEVAX" ECOFERM

Com Tampa Inox Incluída

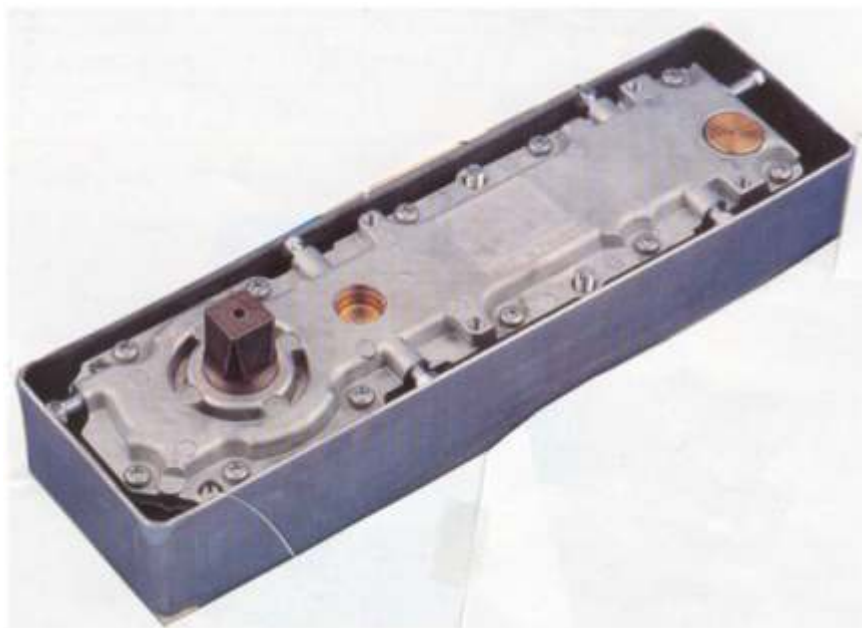

Rua Sebastião e Silva, 47/49









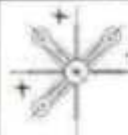

2745-838 MASSAMÁ

Tel: 21 439 60 19 - 21 439 42 57/58

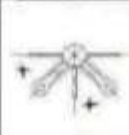
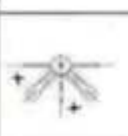
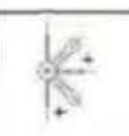
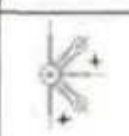
Fax: 21 439 60 20

e-mail: EMAIL@MASSAVIDRO.PT

FERRAGENS PARA VIDRO "SEVAX"

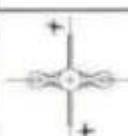
 FL4B1122	 FL3B1120	 FL3B1022
 FL3B1102	 FL3B0122	 FL2B0011
 FL2B0022	 FL2B0120	 FL2B0210
 FL2B1002	 FL2B2001	 FL1B1000
 FL1B2000	 FL1B0200	 FL2BEL11
 FL2BEL22		

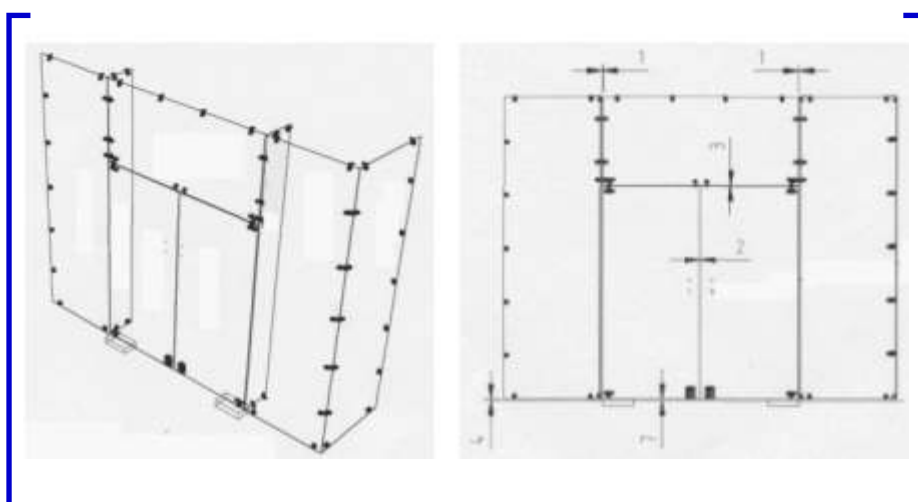

Rua Sebastião e Silva, 47/49

2745-838 MASSAMÁ

Tel: 21 439 60 19 - 21 439 42 57/58

Fax: 21 439 60 20

e-mail: EMAIL@MASSAVIDRO.PT

PANÉIS E ACESSÓRIOS

Painéis de Portas PORTALUXE



CAROLINA
(PO)



NEW YORK
(PN)



UTHAT
(PU)



FLORIDA
(PF)



LUISIANA
(PS)



TEXAS
(PX)



NEW JERSEY
(PJ)



CALIFORNIA
(PC)



VIRGÍNIA
(PG)



NEVADA
(PV)



COLORADO
(PD)



ALASKA
(PL)



INDIANA
(PI)



MONTANA
(PM)



DAKOTA
(PK)



ARIZONA
(PA)



LATERAL 1
(PT)



LATERAL 2
(PR)



UTHAT



FLORIDA



LUISIANA



TEXAS



NEW JERSEY



CALIFORNIA

Rua Sebastião e Silva, 47/49

2745-838 MASSAMÁ

Tel: 21 439 60 19 - 21 439 42 57/58

Fax: 21 439 60 20

e-mail: EMAIL@MASSAVIDRO.PT

PANÉIS E ACESSÓRIOS

Painéis de Portas



Chapas Decorativas

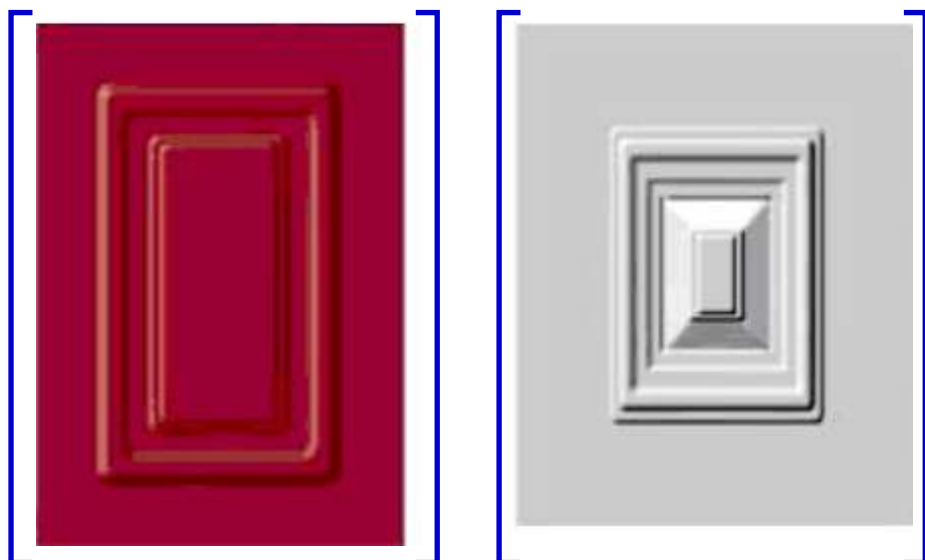

Rua Sebastião e Silva, 47/49

2745-838 MASSAMÁ

Tel: 21 439 60 19 - 21 439 42 57/58

Fax: 21 439 60 20

e-mail: EMAIL@MASSAVIDRO.PT

PANÉIS E ACESSÓRIOS

Ferragens para Portas



VISOR

Rua Sebastião e Silva, 47/49

2745-838 MASSAMÁ

Tel: 21 439 60 19 - 21 439 42 57/58

Fax: 21 439 60 20

e-mail: EMAIL@MASSAVIDRO.PT

MATERIAL DE FIXAÇÃO

Parafusos

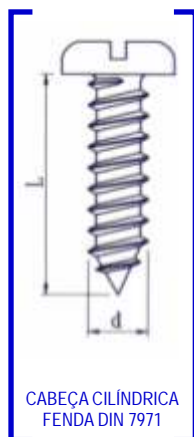

CABEÇA CILÍNDRICA
FENDA DIN 7971

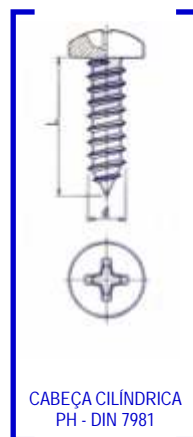

CABEÇA CILÍNDRICA
PH - DIN 7981

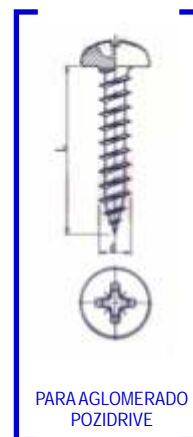

PARAAGLOMERADO
POZIDRIVE

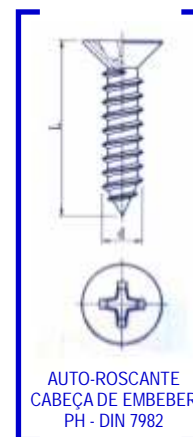

AUTO-ROSCANTE
CABEÇA DE EMBEBER
PH - DIN 7982

Brocas



BROCAS DE AÇO RÁPIDO "HSS"



BROCAS "KVA - SDS PLUS"

Buchas

Diâmetro	Brasa	Diâmetro Parafuso	Comp.
4 mm	4 mm	3,0 - 3,0	25 mm
6 mm	6 mm	3,0 - 4,0	25 mm
8 mm	8 mm	3,0 - 4,0	30 mm
10 mm	8 mm	4,0 - 6,0	40 mm
10 mm	10 mm	6,0 - 8,0	30 mm
12 mm	12 mm	8,0 - 10,0	60 mm
14 mm	14 mm	10,0 - 12,0	70 mm



BUCHAS
NYLON / PLÁSTICO

Type (mm)	4 mm	6 mm	8 mm	10 mm	12 mm	14 mm	16 mm	18 mm	20 mm
1	5	5	6	6	6	8	8	8	8
2	25	26	43	35	42	59	70	45	57
3	5	5	6	6	6	6	8	8	8
4	25	44	55	45	52	70	80	55	74
5	2	6	15	5	12	25	10	5	12

BUCHAS TAPIT

Rua Sebastião e Silva, 47/49

2745-838 MASSAMÁ

Tel: 21 439 60 19 - 21 439 42 57/58

Fax: 21 439 60 20

e-mail: EMAIL@MASSAVIDRO.PT